

IR2130D

3-PHASE DRIVER

Features

- Hermetic
- Floating channels designed for bootstrap operation
Fully operational to +400V
Tolerant to negative transient voltage
dV/dt immune
- Gate drive supply range from 10 to 20V
- Undervoltage lockout for all channels
- Over-current shutdown turns off all six drivers
- Independent half-bridge drivers
- Matched propagation delay for both channels
- Outputs in phase with inputs

Description

The IR2130D is a high voltage, high speed power MOSFET and IGBT driver with three independent high and low side referenced output channels. Proprietary HVIC technology enables ruggedized monolithic construction. Logic inputs are compatible with 5V CMOS or LSTTL outputs. A ground-referenced operational amplifier provides analog feedback of bridge current via an external current sense resistor. A current trip function which terminates all six outputs is also derived from this resistor.

Product Summary

V_{OFFSET}	400V max.
I_{O+/-}	200 mA / 420 mA
V_{OUT}	10 - 20V
t_{on/off} (typ.)	675 & 425 ns
Deadtime (typ.)	0.9 μs

An open drain $\overline{\text{FAULT}}$ signal indicates if an over-current or undervoltage shutdown has occurred. The output driver has a high pulse current buffer stage designed for minimum driver cross-conduction. Propagation delays are matched to simplify use at high frequencies. The floating channels can be used to drive N-channel power MOSFETs or IGBTs in the high side configuration which operate up to 400 volts.

Absolute Maximum Ratings

Absolute Maximum Ratings indicate sustained limits beyond which damage to the device may occur. All voltage parameters are absolute voltages referenced to V_{SO}. The Thermal Resistance and Power Dissipation ratings are measured under board mounted and still air conditions.

Symbol	Parameter	Min.	Max.	Units	
V _{B1,2,3}	High Side Floating Supply Absolute Voltage	-0.3	V _{S1,2,3} + 20	V	
V _{S1,2,3}	High Side Floating Supply Offset Voltage	V _{SO} - 5	V _{SO} + 400		
V _{HO1,2,3}	High Side Output Voltage	V _{S1,2,3} - 0.3	V _{S1,2,3} + 0.3		
V _{CC}	Low Side Fixed Supply Voltage	-0.3	20		
V _{SO}	Low Side Driver Return	-5	V _{CC} + 0.3		
V _{LO1,2,3}	Low Side Output Voltage	V _{SO} - 0.3	V _{CC} + 0.3		
V _{IN}	Logic Input Voltage (HIN, LIN & SD)	-0.3	V _{CC} + 0.3		
V _{FLT}	Fault Output Voltage	-0.3	V _{CC} + 0.3		
V _{CAO}	Operational Amplifier Output Voltage	-0.3	V _{CC} + 0.3		
V _{CA-}	Operational amplifier Inverting Input Voltage	-0.3	V _{CC} + 0.3		
dV _S /dt	Allowable Offset Supply Voltage Transient (Fig. 16)	—	50		V/nS
P _D	Package Power Dissipation @ TA < 25°C (Fig. 19)	—	1.5		W
R _{thJA}	Thermal Resistance, Junction to Ambient	—	70		°C/W
T _J	Junction Temperature	-55	125	°C	
T _S	Storage Temperature	-55	150		
T _L	Lead Temperature (Soldering, 10 seconds)	—	300		
	Weight	6.1 (typical)		g	

Static Electrical Characteristics

V_{BIAS} (V_{CC}, V_{BS1}, 2, 3) = 15V, V_{SO1}, 2, 3 = V_{SS} unless otherwise specified. The V_{IN}, V_{TH} and I_{IN} parameters are referenced to V_{SS} and are applicable to all six logic input leads: HIN1, 2, 3 & LIN1, 2, 3. The V_O and I_O parameters are referenced to V_{SO1}, 2, 3.

Symbol	Parameter	T _j = 25°C			T _j =55-125°C		Units	Test Conditions
		Min.	Typ.	Max.	Min.	Max.		
I _{LK}	Offset Supply Leakage Currents	—	—	50	—	500	μA	V _B = V _S =400V
I _{QBS}	Quiescent V _{BS} Supply Current	—	15	30	—	45		V _{IN} = 0V or 5V
I _{QCC}	Quiescent V _{CC} Supply Current	—	3.0	4.0	—	6.0	mA	V _{IN} = 0V or 5V
I _{IN} ⁺	Logic "1" Input Bias Current(OUT= HI)	—	450	650	—	1050		V _{IN} = 0V
I _{IN} ⁻	Logic "0" Input Bias Current(OUT=LO)	—	225	400	—	—	μA	V _{IN} = 5V
I _{ITRIP} ⁺	"High" ITRIP Bias Current	—	75	150	—	—		ITRIP = 5V
I _{ITRIP} ⁻	"Low" ITRIP Bias Current	—	—	100	—	170	nA	ITRIP =0V
V _{IN.IH}	Logic "0" Input Voltage (OUT = LO)	—	—	—	2.2	—	V	
V _{IN.IL}	Logic "1" Input Voltage (OUT = HI)	—	—	—	—	0.8		
V _{IT,TH} ⁺	ITRIP Input Positive Going Threshold	400	490	580	350	580	mV	
V _{OS}	Amplifier Input Offset Voltage	—	—	30	—	—	mV	V _{SO} = CA- = 0.2V
R _{on,FLT}	FAULT- Low On Resistance	—	55	75	—	150	Ω	
I _{CA} ⁻	CA- Input Bias Current	—	0.5	4.0	—	4.0	nA	CA- = 2.5V
V _{CCUV} ⁺	V _{CC} Supply Undervoltage Positive Going Threshold	8.3	9.0	10.6	8.0	10.7	V	
V _{CCUV} ⁻	V _{CC} Supply Undervoltage Negative Going Threshold	8.0	8.7	10.5	7.7	10.5		
V _{BSUV} ⁺	V _{BS} Supply Undervoltage Positive Going Threshold	7.5	8.4	9.2	—	—	V	
V _{BSUV} ⁻	V _{BS} Supply Undervoltage Negative Going Threshold	7.1	8.0	8.8	—	—		
I _O ⁺	Output High Short Circuit Pulsed Current	200	250	—	—	—	mA	V _{OUT} = V _{IN-} = 0V PW ≤ 10μS
I _O ⁻	Output Low Short Circuit Pulsed Current	420	500	—	—	—		V _{OUT} =15, V _{IN-} =5V PW ≤ 10μS
V _{OH,Amp}	Amplifier High Level Output Voltage	5.0	5.2	5.4	4.9	5.6	V	CA- = 0V, V _{SO} =1V
V _{OL,Amp}	Amplifier Low Level Output Voltage	—	2.5	20	—	20	mV	CA- = 1V, V _{SO} =0V
I _{SRC,Amp}	Amplifier Output Source Current	2.3	4.0	—	1.5	—	mA	CA- = 0V, V _{SO} =1V, CA0=4V
I _{SNK,Amp}	Amplifier Output Sink Current	1.0	2.1	—	0.5	—		CA- = 1V, V _{SO} =0V, CA0=2V
CMRR	Amplifier Common Mode Rejection Ratio	60	80	—	—	—	dB	CA- =V _{SO} =0.1V & 5V
PSRR	Amplifier Power Supply Rejection Ratio	55	75	—	—	—		CA- = V _{SO} =0.2V V _{CC} = 10V & 20V
V _{OH}	High Level Output Voltage	—	—	100	—	100	mV	V _{IN-} = 0V, I _O = 0A
V _{OL}	Low Level Output Voltage	—	—	100	—	100		V _{IN-} = 5V, I _O = 0A

Static Electrical Characteristics Continued

V_{BIAS} (V_{CC} , $V_{BS1, 2, 3}$) = 15V, $V_{SO1, 2, 3}$ = V_{SS} unless otherwise specified. The V_{IN} , V_{TH} and I_{IN} parameters are referenced to V_{SS} and are applicable to all six logic input leads: HIN1, 2, 3 & LIN1, 2, 3. The V_O and I_O parameters are referenced to $V_{SO1, 2, 3}$.

Symbol	Parameter	T _j = 25°C			T _j = 55 to 125°C		Units	Test Conditions
		Min.	Typ.	Max.	Min.	Max.		
$I_{O+, Amp}$	Amplifier Output High Short Circuit Circuit	—	4.5	6.5	—	8.0		CA- = 0V, V_{SO} = 5V V_{CAO} = 0V
$I_{O-, Amp}$	Amplifier Output High Short Circuit Circuit	—	3.2	5.2	—	7.0		CA- = 5V, V_{SO} = 0V V_{CAO} = 5V

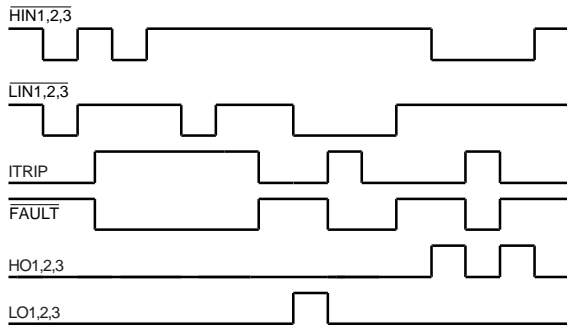

Figure 1. Input/Output Timing Diagram

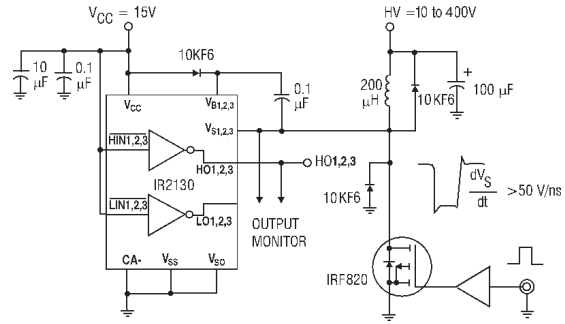

Figure 2. Floating Supply Voltage Transient Test Circuit

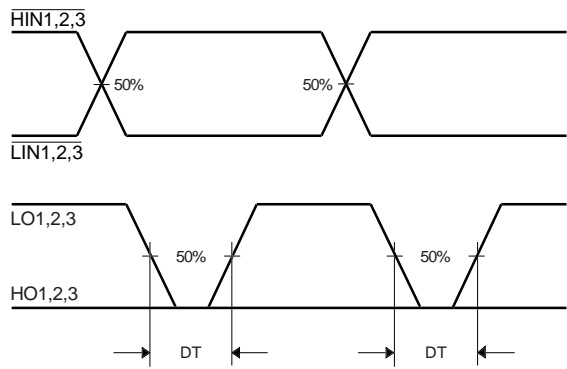

Figure 3. Deadtime Waveform Definitions

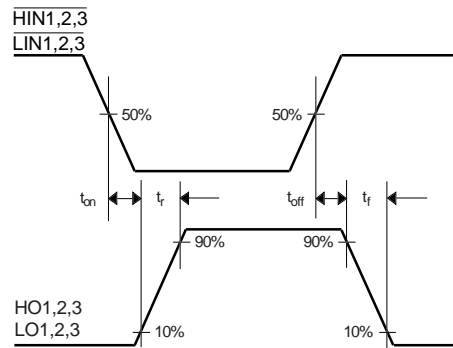

Figure 4. Input/Output Switching Time Waveform Definitions

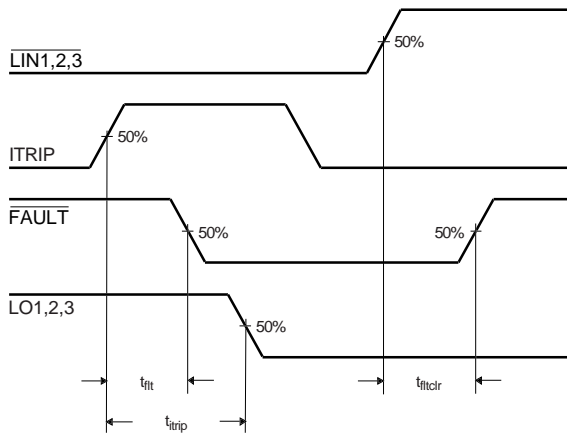

Figure 5. Overcurrent Shutdown Switching Time Waveform Definitions

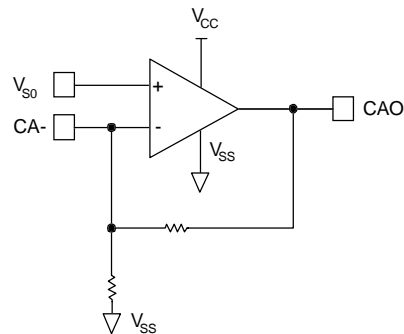

Figure 6. Diagnostic Feedback Operational Amplifier Circuit

IR2130D

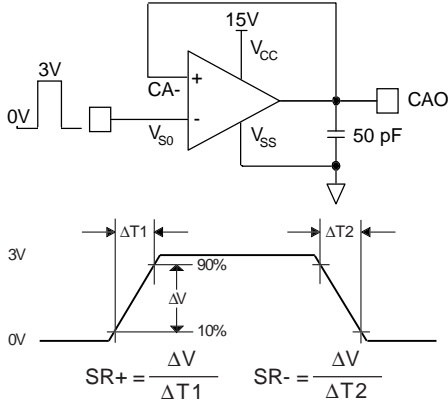

Figure 7. Operational Amplifier Slew Rate Measurement

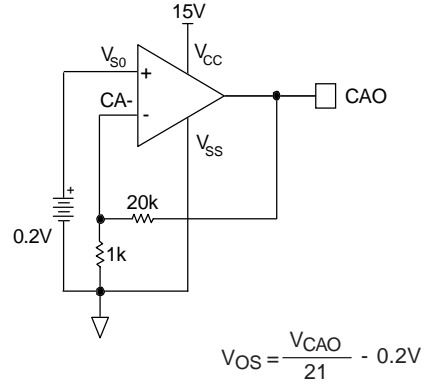

Figure 8. Operational Amplifier Input Offset Voltage Measurement

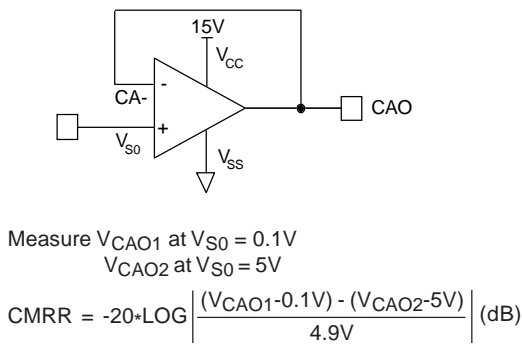

Figure 9. Operational Amplifier Common Mode Rejection Ratio Measurements

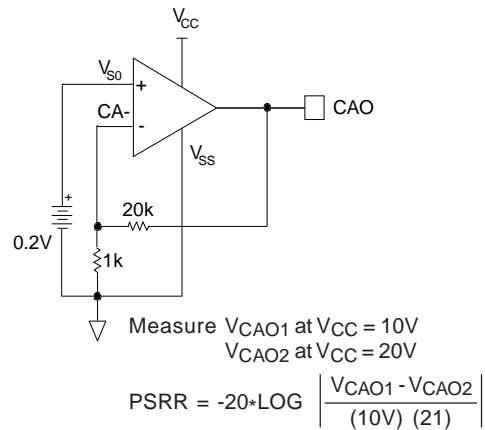

Figure 10. Operational Amplifier Power Supply Rejection Ratio Measurements

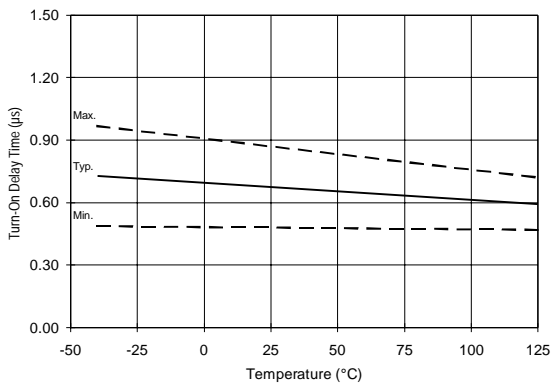

Figure 11A. Turn-On Time vs. Temperature

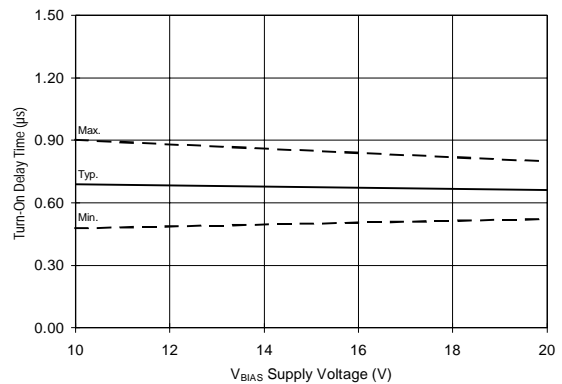

Figure 11B. Turn-On Time vs. Voltage

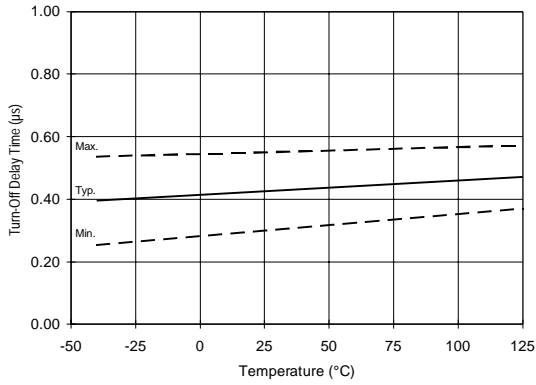

Figure 12A. Turn-Off Time vs. Temperature

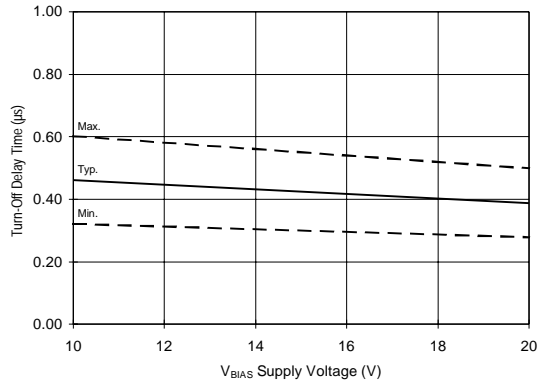

Figure 12B. Turn-Off Time vs. Voltage

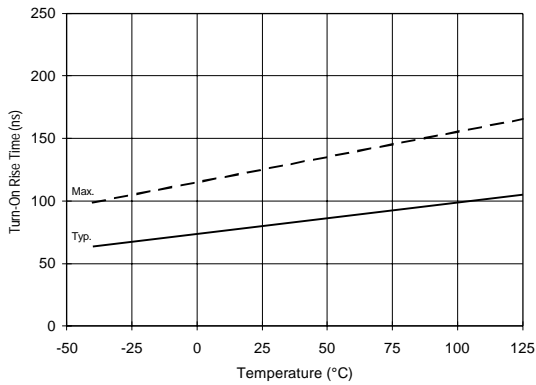

Figure 13A. Turn-On Rise Time vs. Temperature

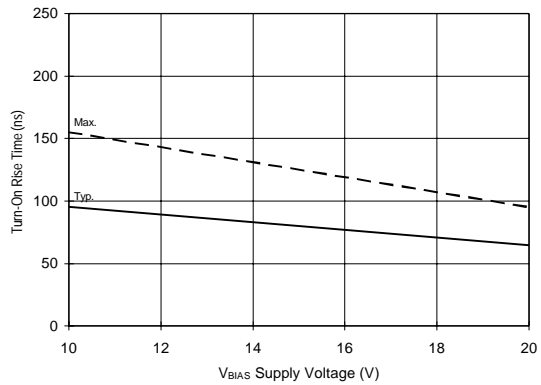

Figure 13B. Turn-On Rise Time vs. Voltage

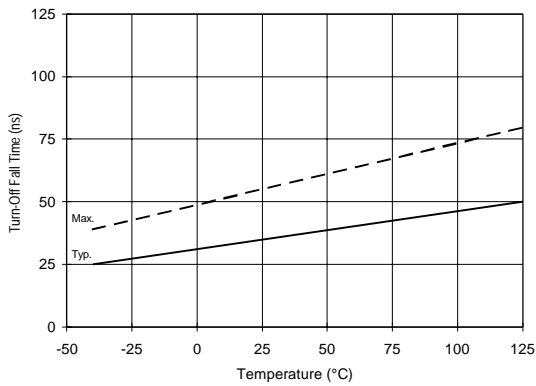

Figure 14A. Turn-Off Fall Time vs. Temperature

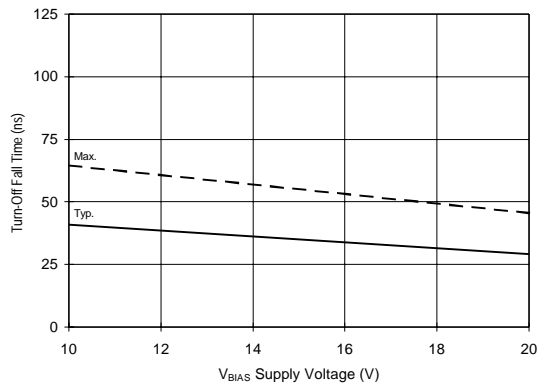

Figure 14B. Turn-Off Fall Time vs. Voltage

IR2130D

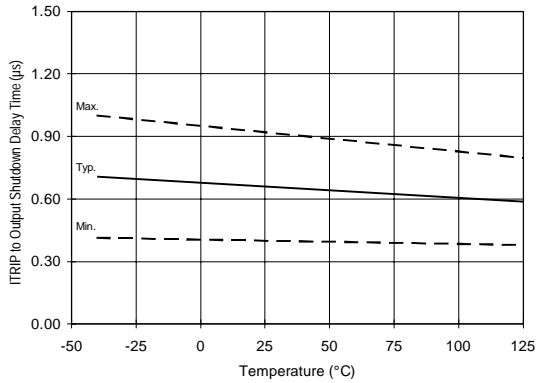

Figure 15A. ITRIP to Output Shutdown Time vs. Temperature

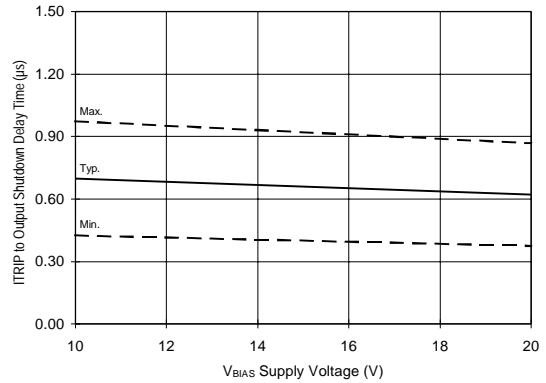

Figure 15B. ITRIP to Output Shutdown Time vs. Voltage

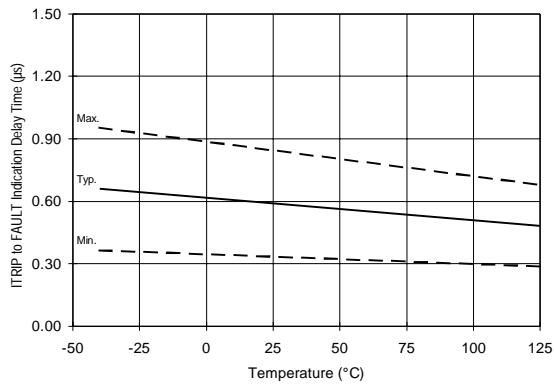

Figure 16A. ITRIP to **FAULT** Indication Time vs. Temperature

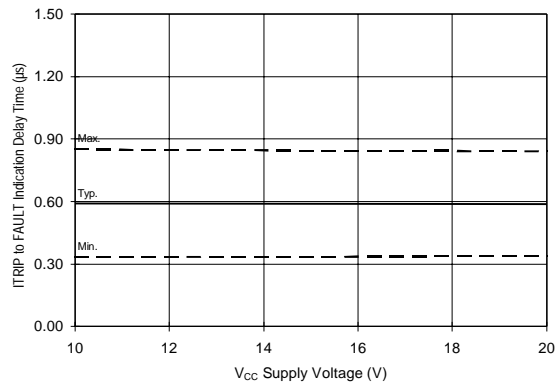

Figure 16B. ITRIP to **FAULT** Indication Time vs. Voltage

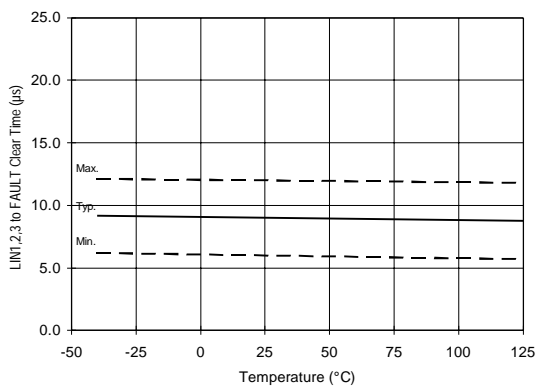

Figure 17A. **LIN1,2,3** to **FAULT** Clear Time vs. Temperature

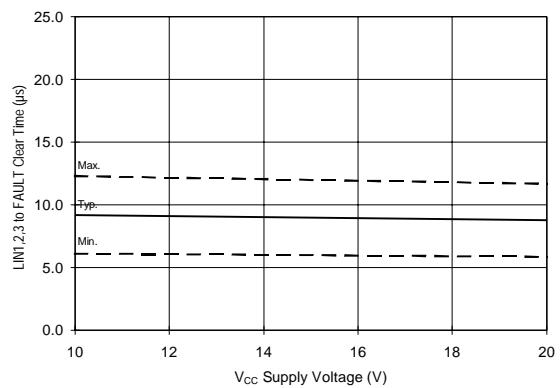

Figure 17B. **LIN1,2,3** to **FAULT** Clear Time vs. Voltage

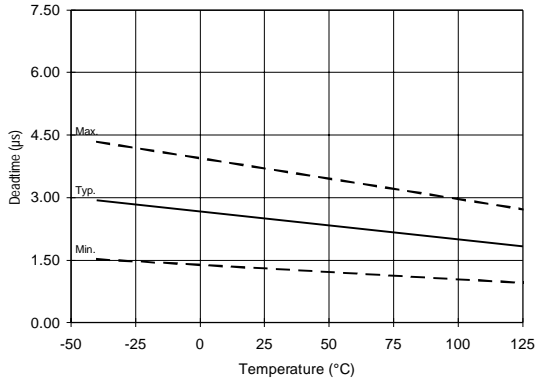

Figure 18A. Deadtime vs. Temperature

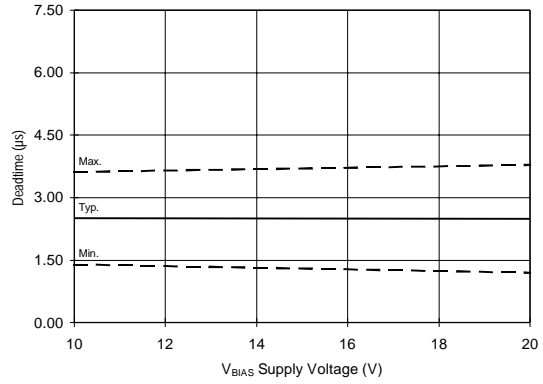

Figure 18B. Deadtime vs. Voltage

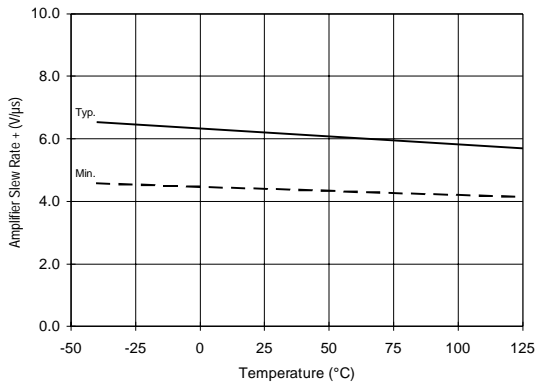

Figure 19A. Amplifier Slew Rate (+) vs. Temperature

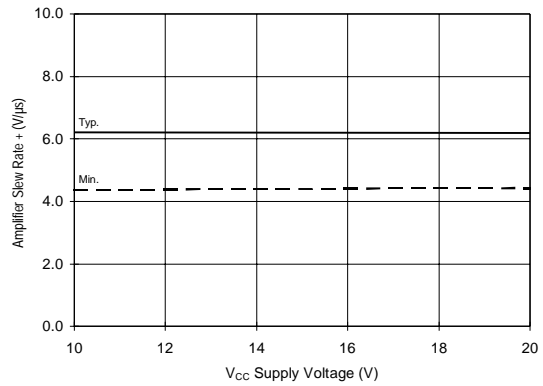

Figure 19B. Amplifier Slew Rate (+) vs. Voltage

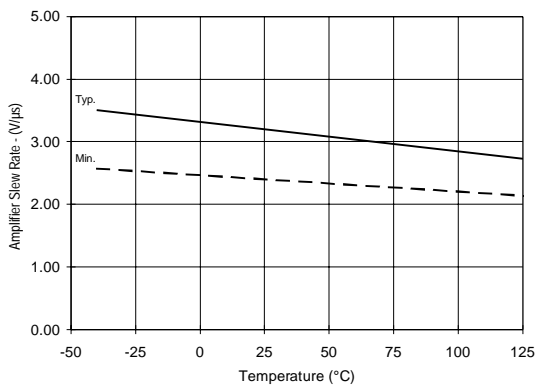

Figure 20A. Amplifier Slew Rate (-) vs. Temperature

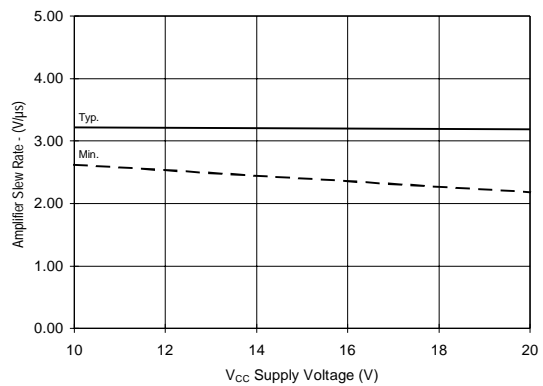

Figure 20B. Amplifier Slew Rate (-) vs. Voltage

IR2130D

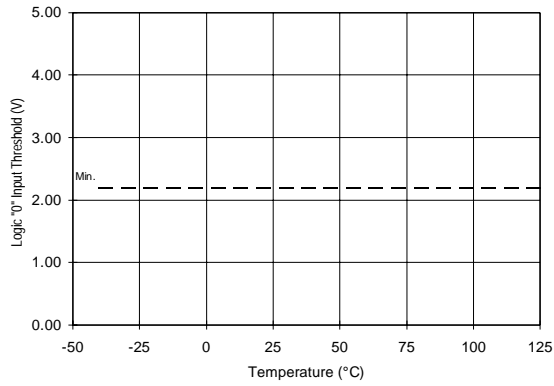

Figure 21A. Logic "0" Input Threshold vs. Temperature

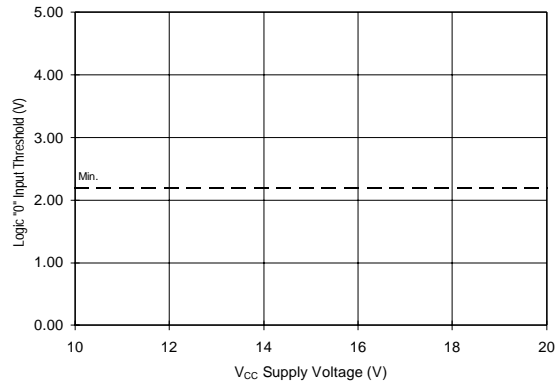

Figure 20B. Logic "0" Input Threshold vs. Voltage

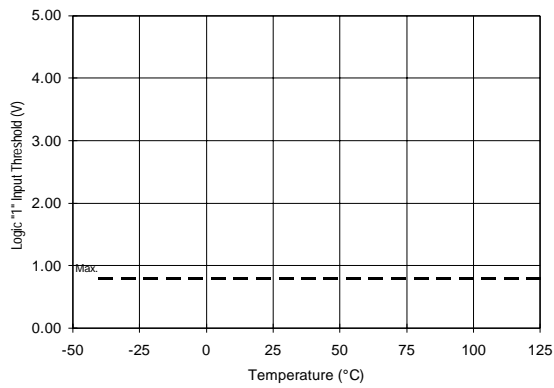

Figure 22A. Logic "1" Input Threshold vs. Temperature

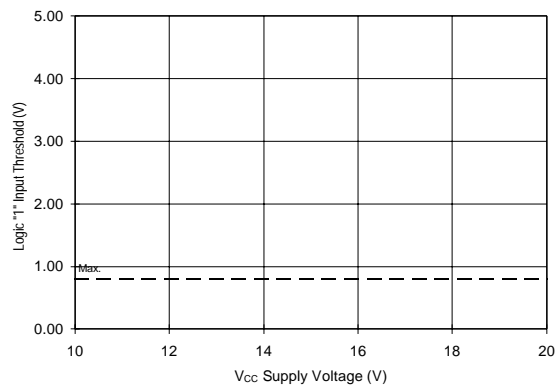

Figure 22B. Logic "1" Input Threshold vs. Voltage

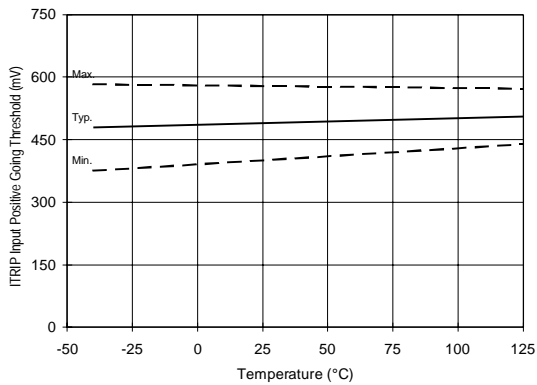

Figure 23A. ITRIP Input Positive Going Threshold vs. Temperature

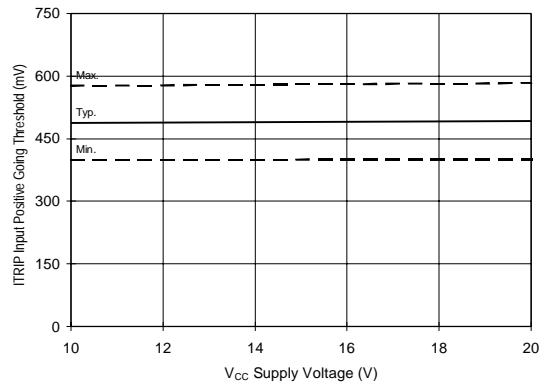

Figure 23B. ITRIP Input Positive Going Threshold vs. Voltage

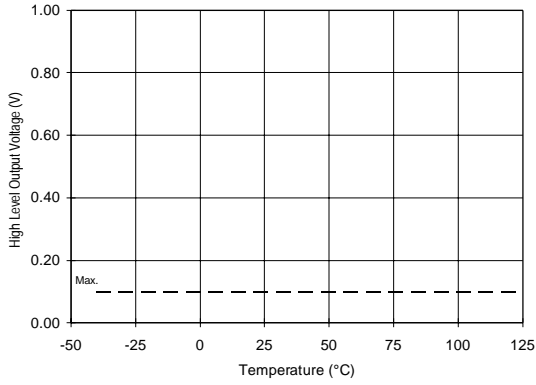

Figure 24A. High Level Output vs. Temperature

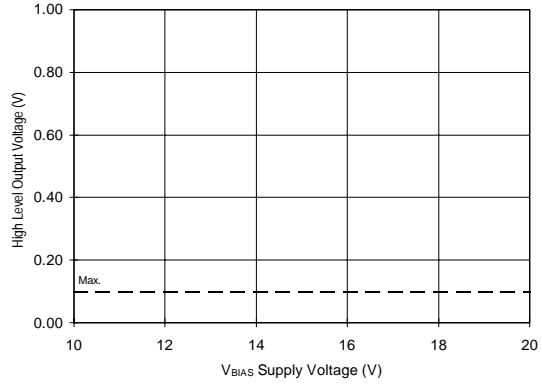

Figure 24B. High Level Output vs. Voltage

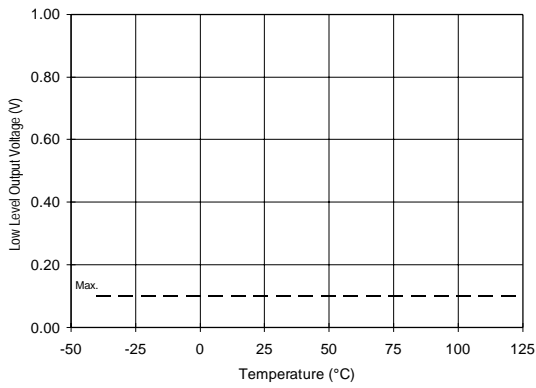

Figure 25A. Low Level Output vs. Temperature

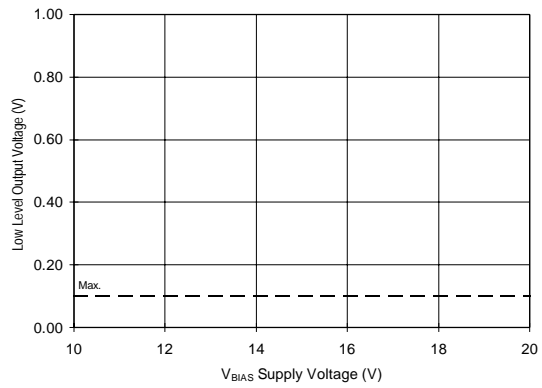

Figure 25B. Low Level Output vs. Voltage

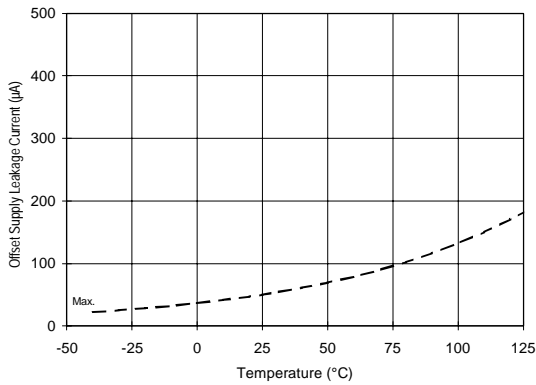

Figure 26A. Offset Supply Leakage Current vs. Temperature

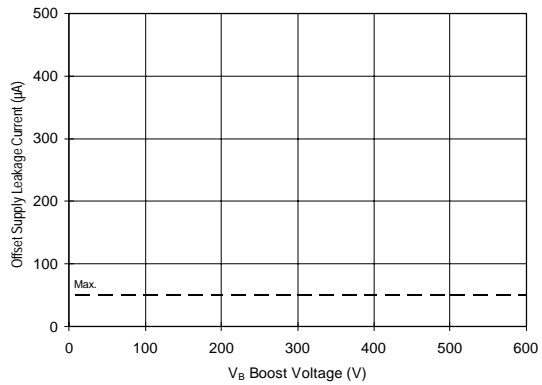

Figure 26B. Offset Supply Leakage Current vs. Voltage

IR2130D

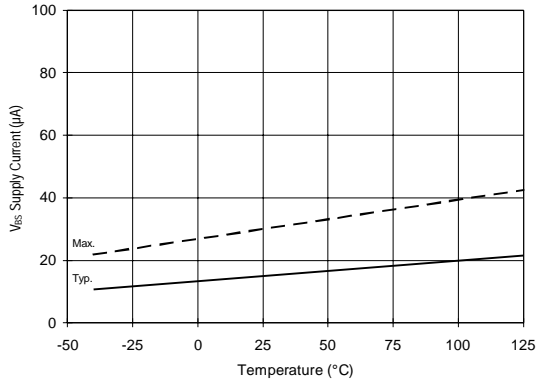

Figure 27A. V_{BS} Supply Current vs. Temperature

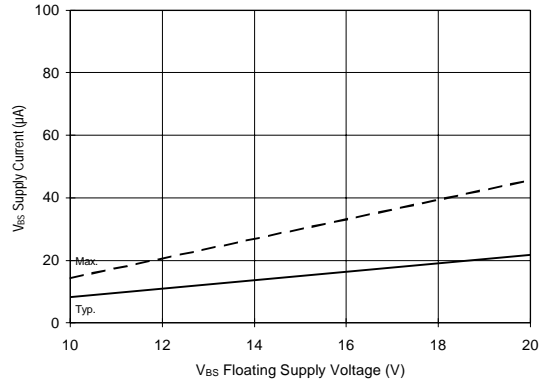

Figure 27B. V_{BS} Supply Current vs. Voltage

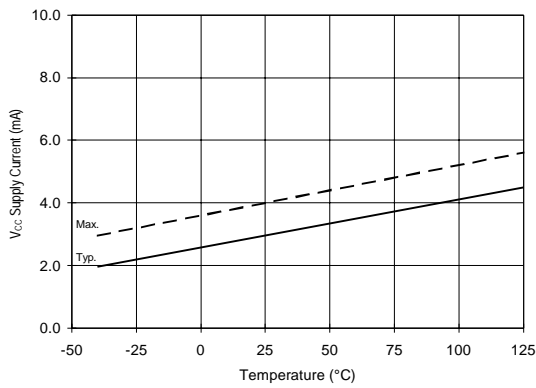

Figure 28A. V_{CC} Supply Current vs. Temperature

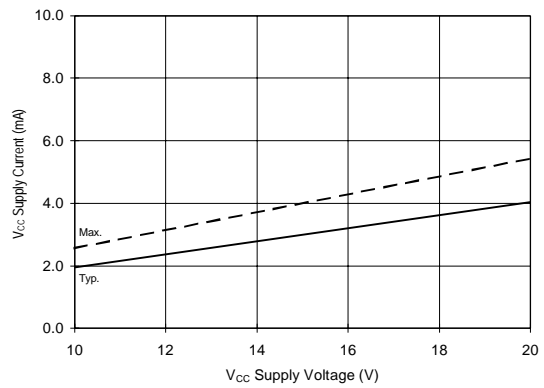

Figure 28B. V_{CC} Supply Current vs. Voltage

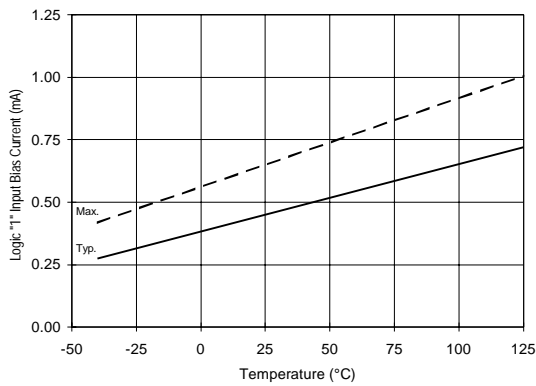

Figure 29A. Logic "1" Input Current vs. Temperature

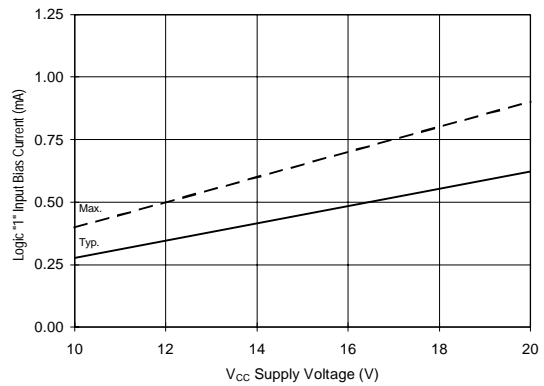

Figure 29B. Logic "1" Input Current vs. Voltage

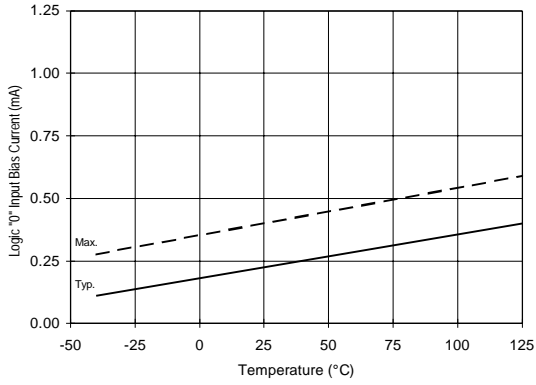

Figure 30A. Logic "0" Input Current vs. Temperature

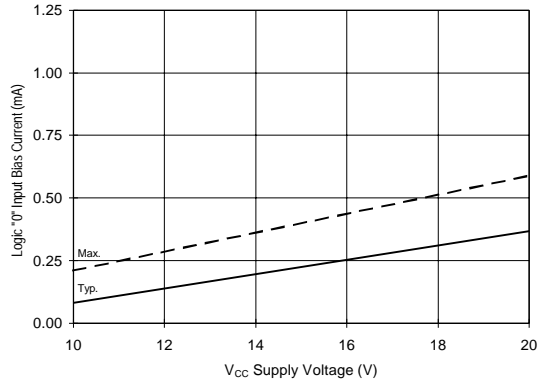

Figure 30B. Logic "0" Input Current vs. Voltage

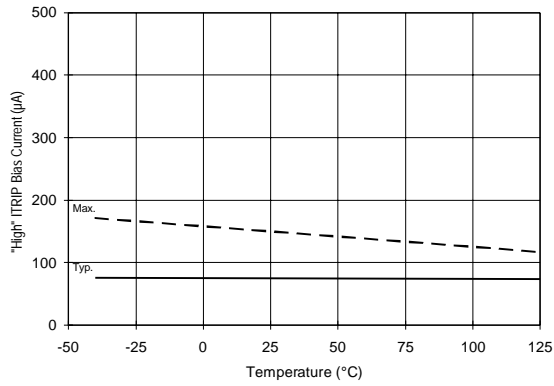

Figure 31A. "High" ITRIP Current vs. Temperature

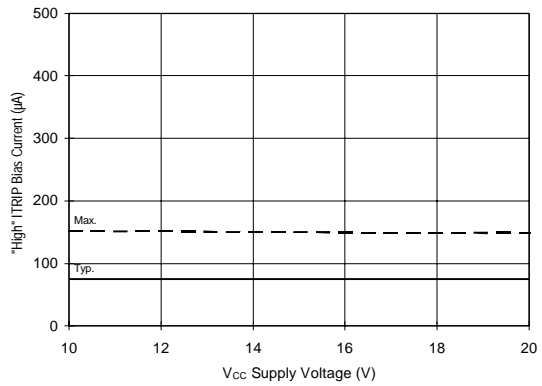

Figure 31B. "High" ITRIP Current vs. Voltage

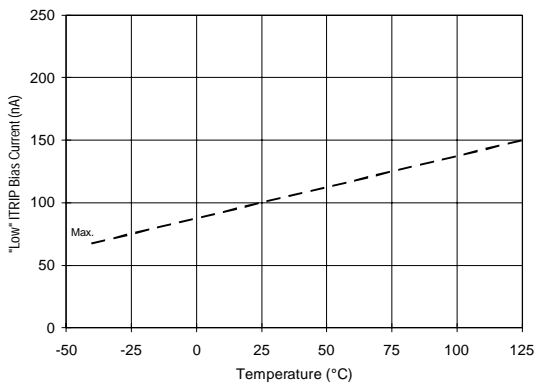

Figure 32A. "Low" ITRIP Current vs. Temperature

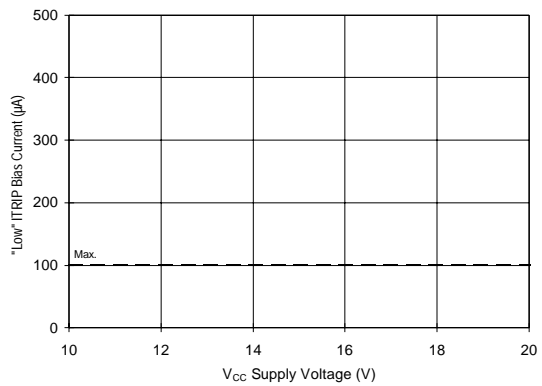

Figure 32B. "Low" ITRIP Current vs. Voltage

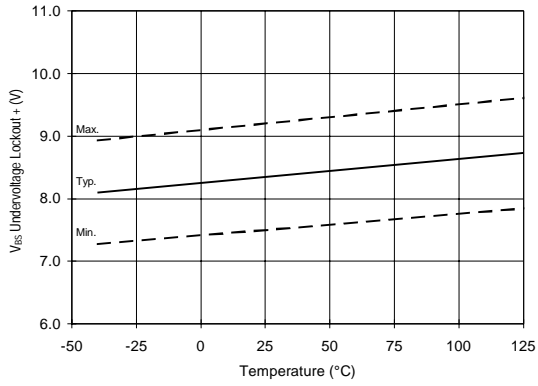

Figure 33. V_{BS} Undervoltage (+) vs. Temperature

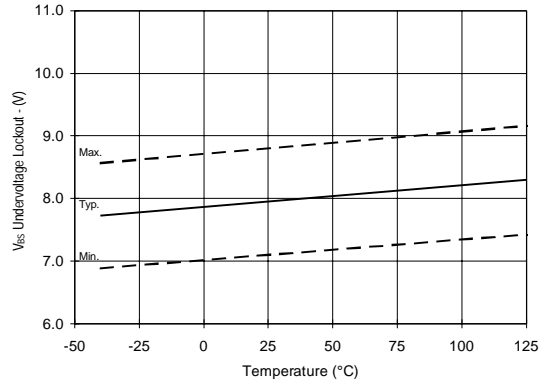

Figure 34. V_{BS} Undervoltage (-) vs. Temperature

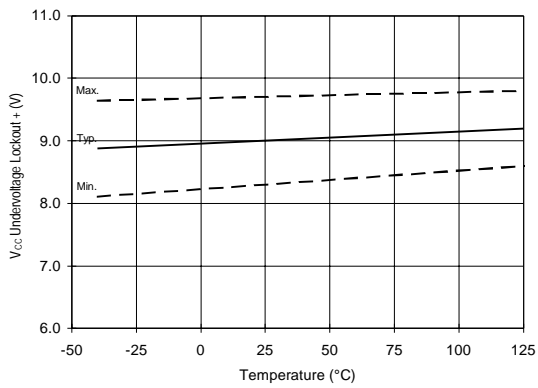

Figure 35. V_{CC} Undervoltage (+) vs. Temperature

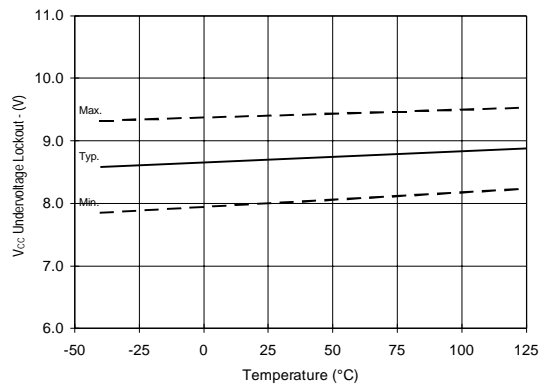

Figure 36. V_{CC} Undervoltage (-) vs. Temperature

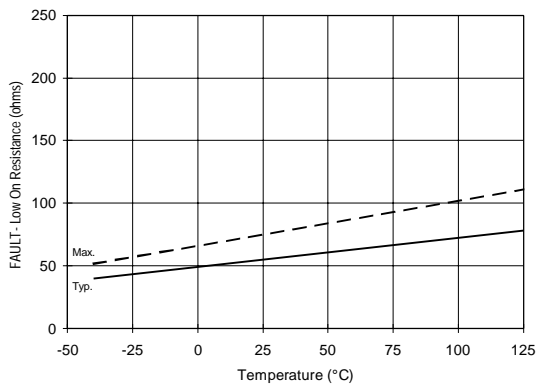

Figure 37A. $\overline{\text{FAULT}}$ Low On Resistance vs. Temperature

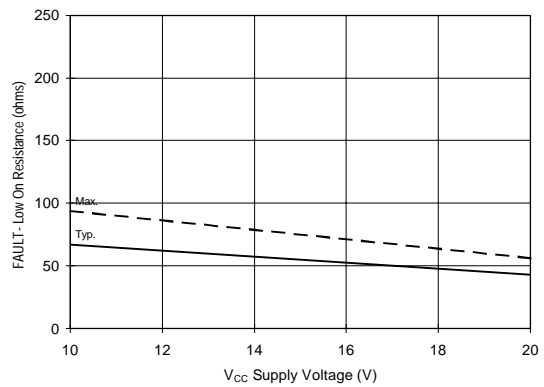

Figure 37B. $\overline{\text{FAULT}}$ Low On Resistance vs. Voltage

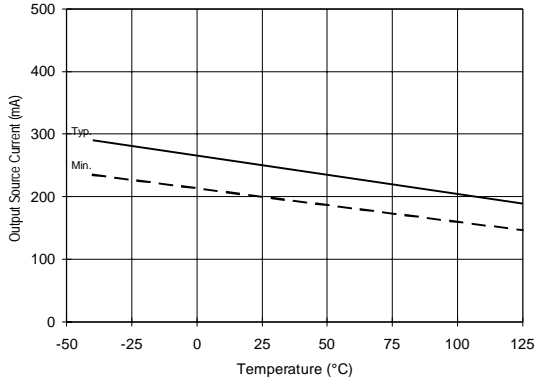

Figure 38A. Output Source Current vs. Temperature

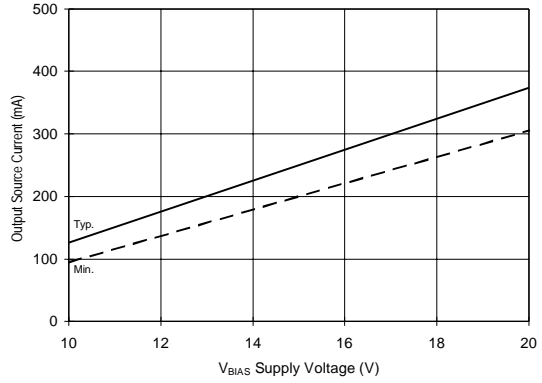

Figure 38B. Output Source Current vs. Voltage

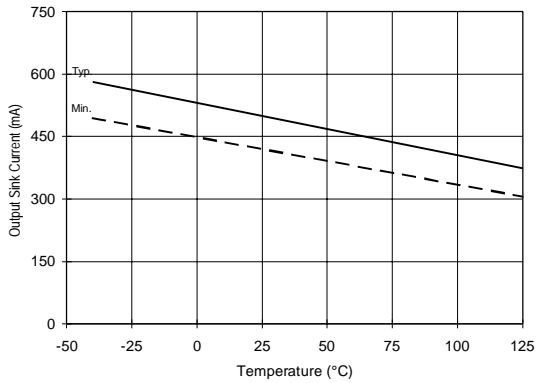

Figure 39A. Output Sink Current vs. Temperature

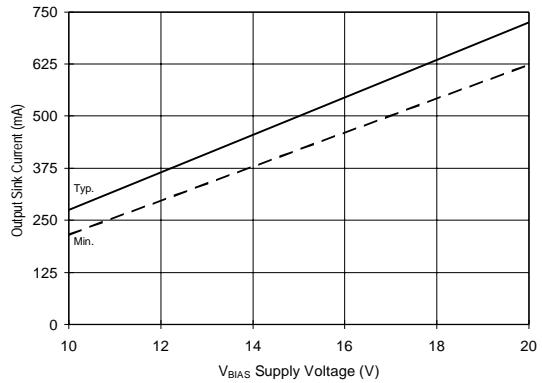

Figure 39B. Output Sink Current vs. Voltage

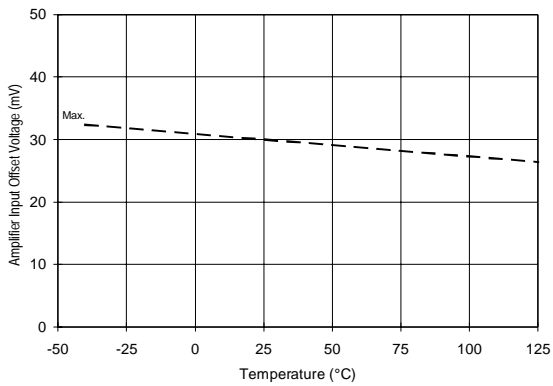

Figure 40A. Amplifier Input Offset vs. Temperature

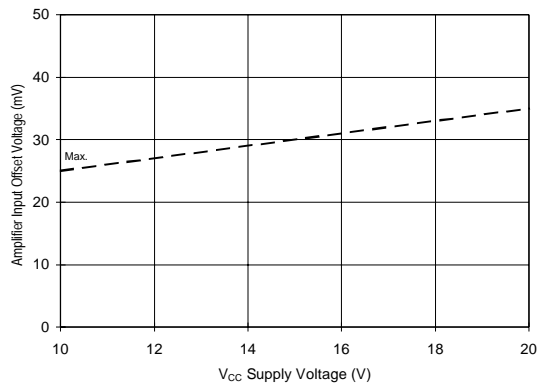

Figure 40B. Amplifier Input Offset vs. Voltage

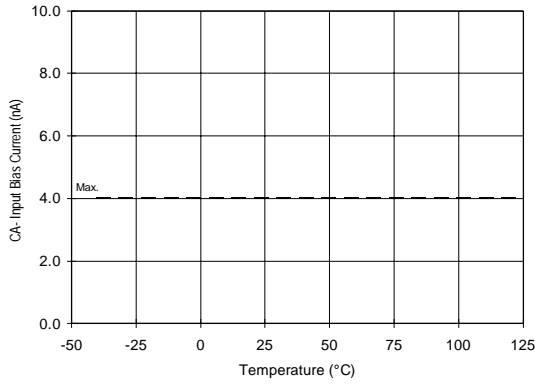

Figure 41A. CA- Input Current vs. Temperature

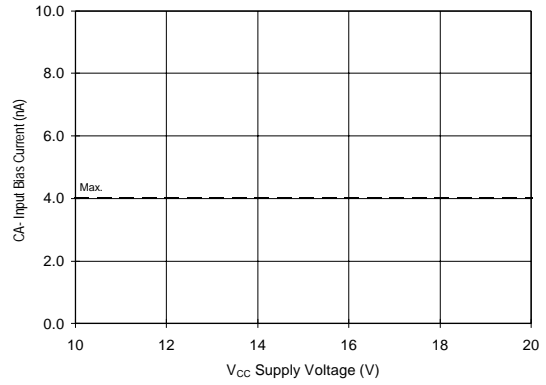

Figure 41B. CA- Input Current vs. Voltage

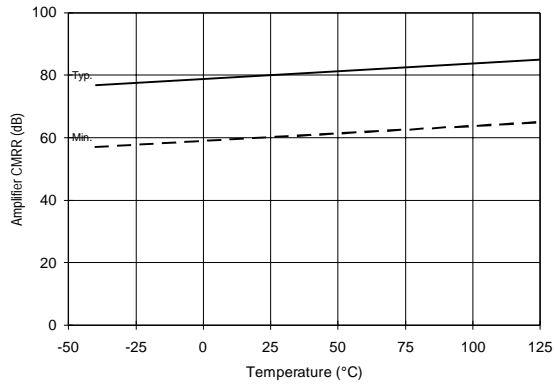

Figure 42A. Amplifier CMRR vs. Temperature

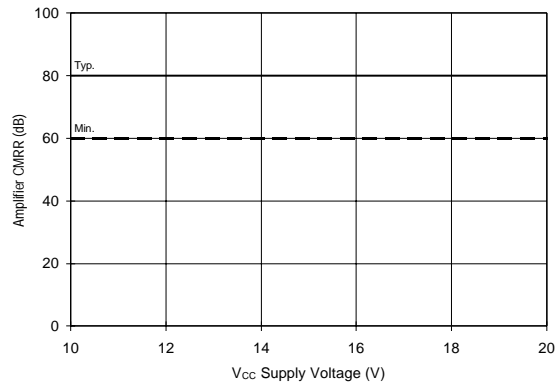

Figure 42B. Amplifier CMRR vs. Voltage

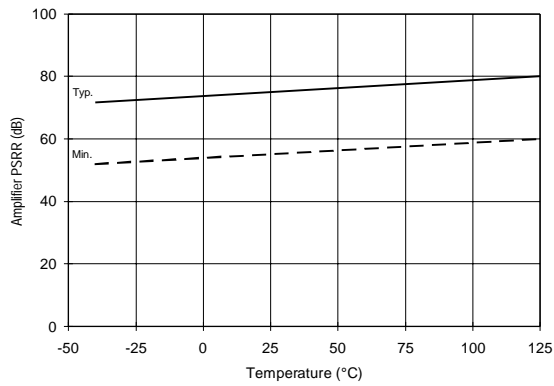

Figure 43A. Amplifier PSRR vs. Temperature

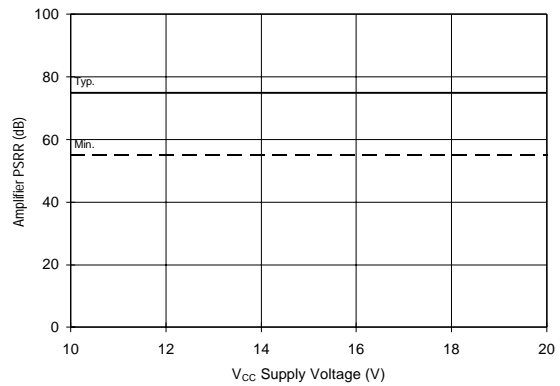

Figure 43B. Amplifier PSRR vs. Voltage

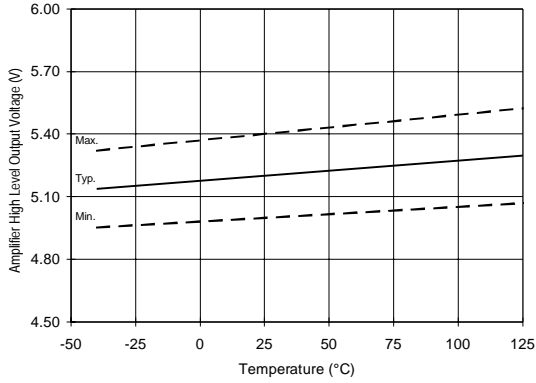

Figure 44A. Amplifier High Level Output vs. Temperature

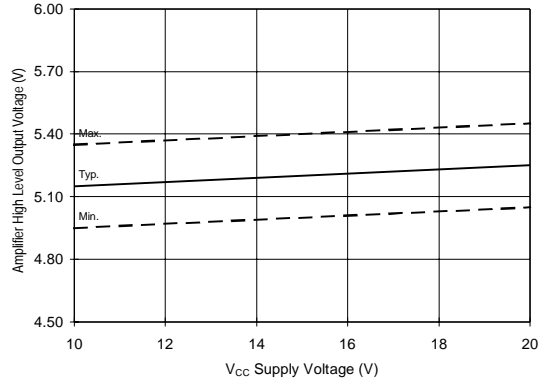

Figure 44B. Amplifier High Level Output vs. Voltage

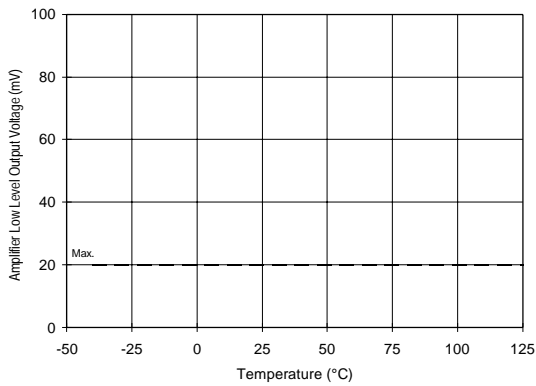

Figure 45A. Amplifier Low Level Output vs. Temperature

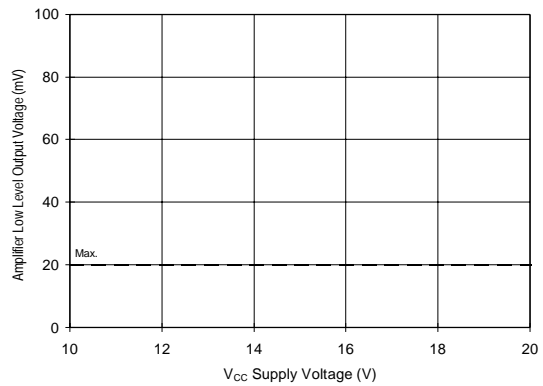

Figure 45B. Amplifier Low Level Output vs. Voltage

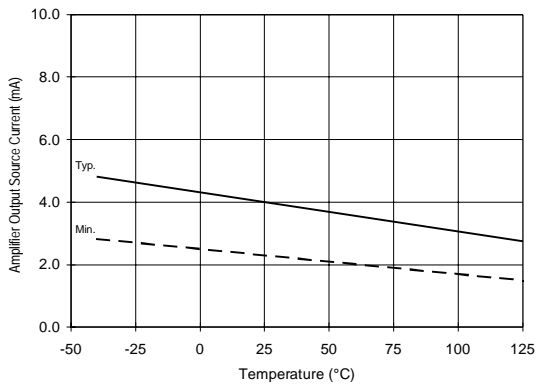

Figure 46A. Amplifier Output Source Current vs. Temperature

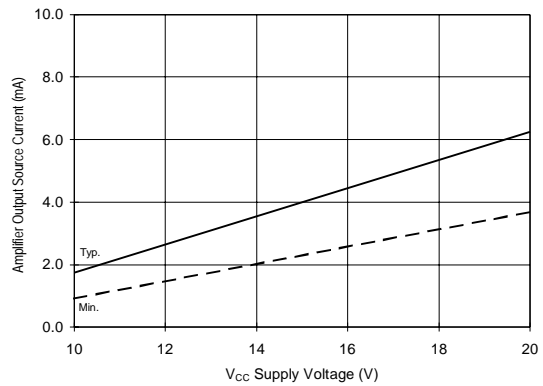

Figure 46B. Amplifier Output Source Current vs. Voltage

IR2130D

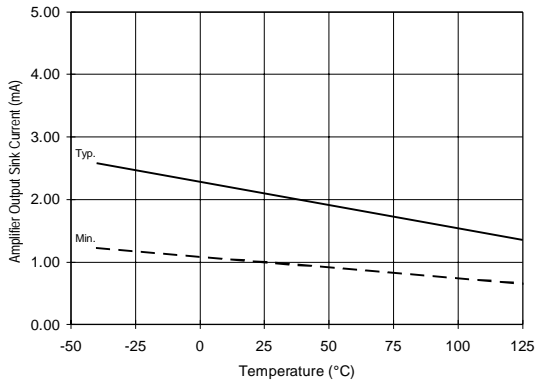

Figure 47A. Amplifier Output Sink Current vs. Temperature

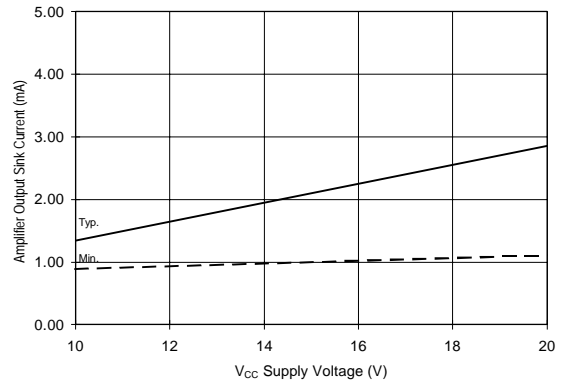

Figure 47B. Amplifier Output Sink Current vs. Voltage

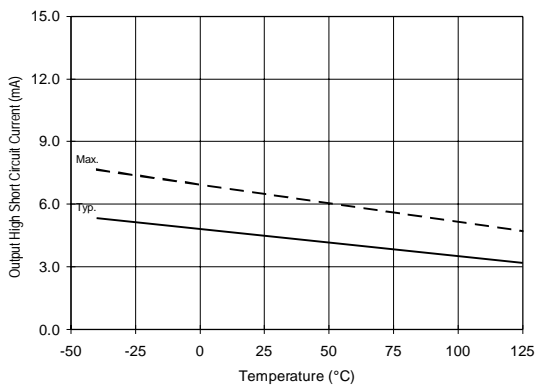

Figure 48A. Amplifier Output High Short Circuit Current vs. Temperature

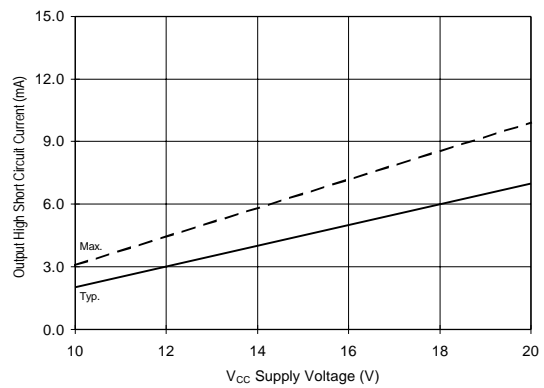

Figure 48B. Amplifier Output High Short Circuit Current vs. Voltage

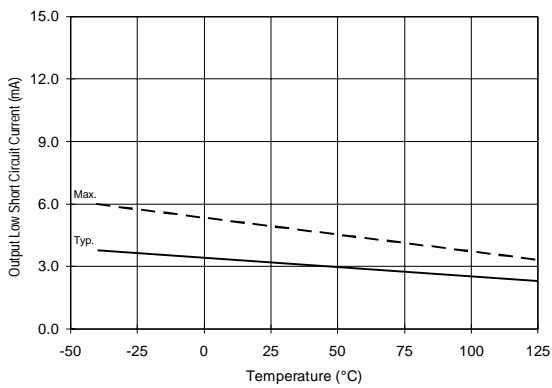

Figure 49A. Amplifier Output Low Short Circuit Current vs. Temperature

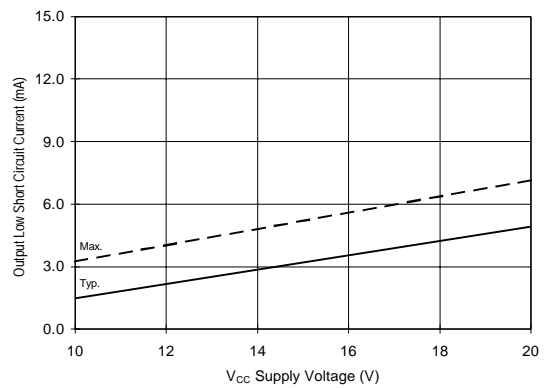

Figure 49B. Amplifier Output Low Short Circuit Current vs. Voltage

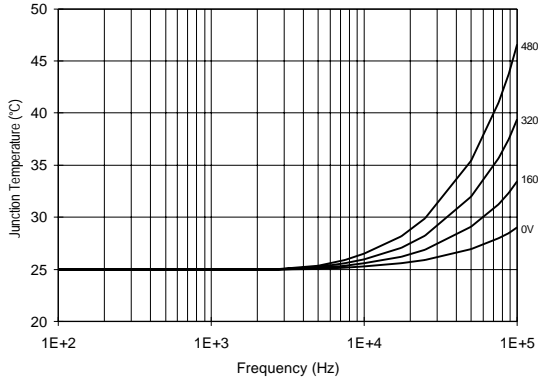

Figure 50. IR2130 T_J vs. Frequency (IRF820)
 R_{GATE} = 33W, V_{CC} = 15V

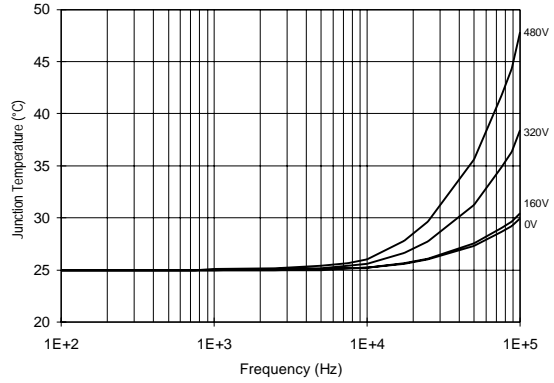

Figure 51. IR2130 T_J vs. Frequency (IRF830)
 R_{GATE} = 20W, V_{CC} = 15V

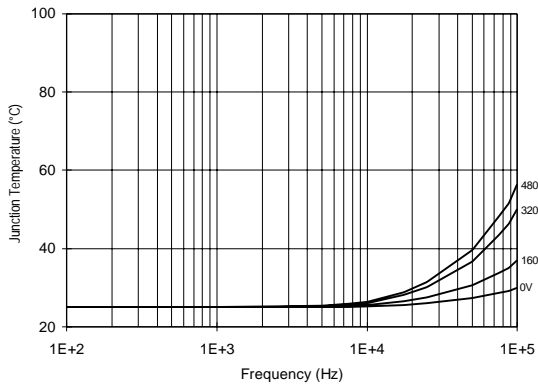

Figure 52. IR2130 T_J vs. Frequency (IRF840)
 R_{GATE} = 15W, V_{CC} = 15V

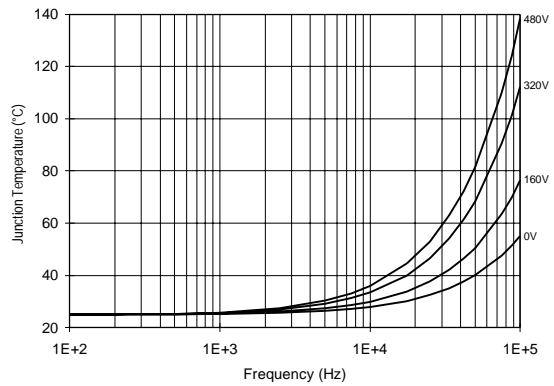

Figure 53. IR2130 T_J vs. Frequency (IRF450)
 R_{GATE} = 10W, V_{CC} = 15V

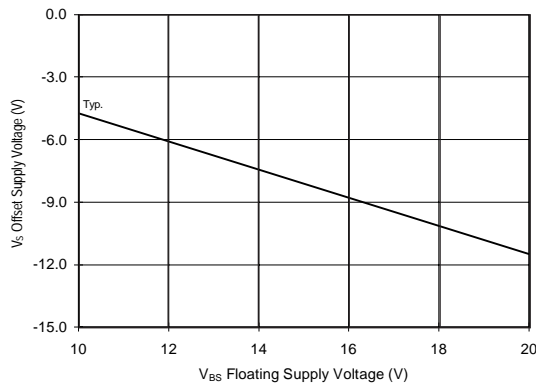
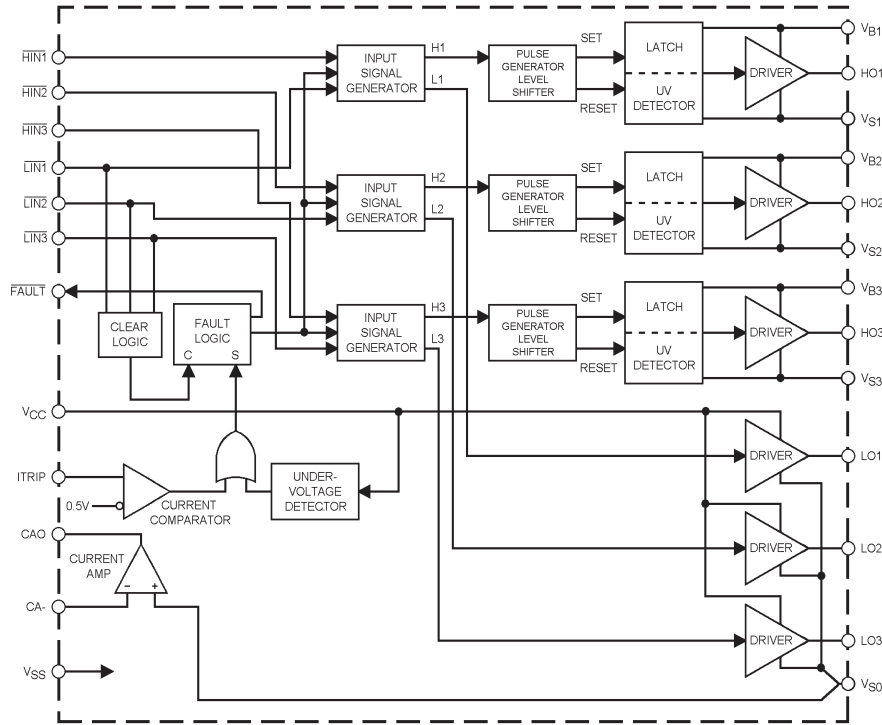

Figure 54. Maximum VS Negative Offset vs. V_{BS} Supply Voltage

Functional Block Diagram



Lead Definitions

Lead	
Symbol	Description
HIN1,2,3	Logic inputs for high side gate driver outputs (HO1,2,3), out of phase
LIN1,2,3	Logic inputs for low side gate driver output (LO1,2,3), out of phase
FAULT	Indicates over-current or undervoltage lockout (low side) has occurred, negative logic
VCC	Low side and logic fixed supply
ITRIP	Input for over-current shutdown
CAO	Output of current amplifier
CA-	Negative input of current amplifier
VSS	Logic ground
VB1,2,3	High side floating supplies
HO1,2,3	High side gate drive outputs
VS1,2,3	High side floating supply returns
LO1,2,3	Low side gate drive outputs
VS0	Low side return and positive input of current amplifier

Case Outline and dimensions - MO038AB

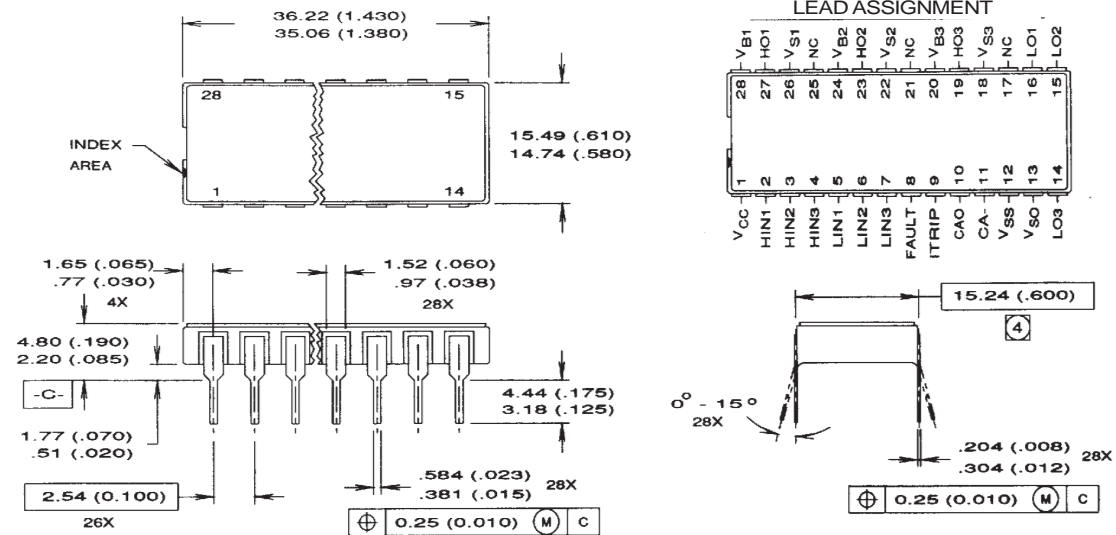

- NOTES:
- 1 DIMENSIONING & TOLERANCING PER ANSI Y14.5M, 1982.
 - 2 CONTROLLING DIMENSION : INCH.
 - 3 DIMENSIONS ARE SHOWN IN MILLIMETERS (INCHES).
 - 4 DIMENSION IS TO CENTER OF LEADS WHEN FORMED PARALLEL.
 - 5 OUTLINE CONFORMS TO JEDEC OUTLINE MO-038AB.

IR WORLD HEADQUARTERS: 233 Kansas St., El Segundo, California 90245, USA Tel: (310) 252-7105
IR EUROPEAN REGIONAL CENTER: 439/445 Godstone Rd, Whyteleafe, Surrey CR3 0BL, UK Tel: ++ 44 (0)20 8645 8000
IR CANADA: 15 Lincoln Court, Brampton, Ontario L6T3Z2, Tel: (905) 453 2200
IR GERMANY: Saalburgstrasse 157, 61350 Bad Homburg Tel: ++ 49 (0) 6172 96590
IR ITALY: Via Liguria 49, 10071 Borgaro, Torino Tel: ++ 39 011 451 0111
IR JAPAN: K&H Bldg., 2F, 30-4 Nishi-Ikebukuro 3-Chome, Toshima-Ku, Tokyo 171 Tel: 81 (0)3 3983 0086
IR SOUTHEAST ASIA: 1 Kim Seng Promenade, Great World City West Tower, 13-11, Singapore 237994 Tel: ++ 65 (0)838 4630
IR TAIWAN: 16 Fl. Suite D. 207, Sec. 2, Tun Haw South Road, Taipei, 10673 Tel: 886-(0)2 2377 9936

Data and specifications subject to change without notice. 3/00